

OPERATING INSTRUCTIONS



ESE 3000 BS
240 209

ESE 6000 BS
240 210

ESE 6000 DBS
240 211

Published by ENDRESS Elektrogerätebau GmbH

Neckartenzlinger Straße 39
D-72658 Bempflingen

Email: info@endress-generators.de

WWW: <http://www.endress-generators.de>

Document number E133811

Date of issue January 2011

Copyright © 2010, ENDRESS Elektrogerätebau GmbH

This documentation, including all parts thereof, is protected by copyright. Every use and adaptation outside of what is strictly authorised under the copyright law is, without the permission of the ENDRESS Elektrogerätebau GmbH Company, illegal and punishable by law.

This applies in particular to reproductions, translations, copying by microfilming and storage and processing in electronic systems.

List of Contents

1	About these instructions	5
1.1	Signs and Symbols used.....	6
1.1.1	General Signs / Symbols.....	6
1.1.2	Safety symbols.....	7
2	General Safety Guidelines	8
2.1	Intended Use	8
2.1.1	Intended use.....	8
2.1.2	Foreseeable misuse and incorrect operation.....	9
2.1.3	Residual Risks.....	10
2.2	Qualifications and Duties	12
2.3	Personal Safety Equipment.....	12
2.4	Hazard Areas and Work Places	12
2.5	Labelling on the Power Generator.....	13
2.6	General Safety Instructions.....	15
3	Description	19
3.1	Function and Mode of Operation.....	20
4	Putting the Power Generator into Operation	21
4.1	Dismantle the transport safety device	21
4.1	Transporting the Power Generator.....	22
4.2	Setting-up the Power Generator.....	23
4.3	Fuelling the Power Generator	24
4.4	Filling the Power Generator with Motor Oil.....	25
4.5	Starting the Power Generator.....	27

4.6	Switching off the Power Generator.....	33
4.7	Shutting down Power Generator (longer term shut down).....	34
5	Servicing the Power Generator.....	38
5.1	Service Plan.....	38
5.2	Servicing work	39
5.3	Checking Electrical Safety	39
6	Trouble Shooting	40
7	Technical Data.....	42
8	Terms of Warranty	45

1 About these instructions



Before you use this power generator, carefully read and make sure you understand these instructions.

These instructions are intended to enable you to understand the basic operating principles of the power generator.

These instructions contain important information on how to use this power generator in a correct and safe manner.

Following the instructions will help:

- to avoid dangers
- to minimise costs of repair and down-time
- to increase the dependability and operational life of the power generator.

Irrespective of these instructions, the laws, regulations and guidelines of the country and location where the generator is operated must be observed.

Irrespective of these instructions, the locally applicable laws for health and safety and the regulations for the protection of the environment pertaining to the country and location where the generator is operated must be observed.

These instructions only provide information regarding the use of the power generator.

A copy of these instructions must be made available at all times to the operating personnel.

1.1 Signs and Symbols used

The signs and symbols in these instructions are designed to assist in the understanding of the instructions and to enable the operator to commence use of the generator quickly and safely.

1.1.1 General Signs / Symbols



Advanced Organizer

The Advanced Organizer provides brief information on the content of the following section.

NOTE Notes provide hints and information to assist you to make the most effective and practical use of the generator and these instructions.

1. Work steps

2.

3.

The prescribed order of the work steps will make it easier for you to operate the generator correctly and safely.

✓ **Result**

Here you will find the description of the result achieved by the completion of the work steps.

1.1.2 Safety symbols

Safety symbols highlight a source of danger.



Warning about a general danger

These warning symbols indicate activities that could lead to several sources of danger.



Warning about explosive materials

These warnings symbols indicate activities that could lead to the risk of explosion with possibly fatal consequences.



Warning about danger from electrical voltage

These warning symbols indicate activities that could lead to the risk of an electric shock with possibly fatal consequences.



Warning on environmentally damaging substances

This warning sign indicates activities, during which the environment could be endangered, possibly with catastrophic consequences.



Warning on hot surfaces

This warning sign indicates activities, during which there is the danger of burns, possibly with lasting consequences.

2 General Safety Guidelines



In this section you will find the basic safety guidelines for operation of the power generator.

Every person who operates the power generator, or works with someone who operates the power generator is obliged to read this chapter and observe the guidelines when operating the power generator.

2.1 Intended Use

The power generator conforms to the most up-to-date standards of science and technology, as well as to the safety regulations currently applicable at the time the product is put into circulation.

Incorrect use and residual risks cannot be constructively prevented without reducing the function of the intended use.

Information about risks of danger is conveyed either directly by the generator itself and/or by the technical documentation.

2.1.1 Intended use

The power generator is a mains replacement that generates electrical power for supply to a mobile distribution system.

The power generator must be operated outdoors within the prescribed voltage, output and rated speed limits (see type plate).

The power generator must not be connected to other electrical supply systems (e.g. public electrical supply) or electric generation systems (e.g. other power generators).

The power generator may not be used in environments where there is a risk of explosion.

The power generator may not be used in environments where there is a risk of fire.

The power generator must be operated in accordance with the conditions set out in the technical documentation.

All improper use of the power generator including all uses not described in these instructions will constitute unauthorised incorrect usage for which the manufacturer is not legally liable.

2.1.2 Foreseeable misuse and incorrect operation

Instances of foreseeable misuse and/or incorrect operation of the power generator invalidate the manufacturer's EU declaration of conformity, together with the operating license.

Foreseeable misuse and/or incorrect operation includes:

- Operation in environments where there is a risk of explosion
- Operation in environments where there is a risk of fire
- Operation in enclosed areas
- Operation under direct exposure to rain or snowfall
- Operation without the requisite safety precautions
- Operation connected to existing supply network systems
- Refuelling when hot
- Refuelling when in operation
- Spraying with high-pressure cleaners or fire extinguishing equipment
- Operation when safety devices are removed
- Non-compliance with regular servicing requirements
- Failure to carry out measurements and checks for early detection of defects.
- Failure to replace wear and tear parts
- Improper servicing and repairs
- Inadequate servicing and repairs
- Incorrect operation

2.1.3 Residual Risks

Analysed and evaluated by means of a risk assessment undertaken prior to the planning and construction of the power generator.

Residual risks that are constructively unavoidable and which may arise during the operating life of the power generator are:

- Danger to life
- Risk of injury
- Environmental hazards
- Material damage to the power generator
- Material damage to other material property
- Reduction in performance and functionality

You can avoid existing residual risks by implementing and observing the following guidelines:

- the special warning notices on the power generator
- the general safety notices in these instructions
- the special warning notices in these instructions

Danger to Life Danger to the life of persons from the power generator can arise through:

- Misuse
- Incorrect operation
- Improper safety equipment
- Defective or damaged electrical components
- Touching with wet hands
- Fuel vapours
- Engine exhaust fumes

Risk of Injury Risk of injury to persons from the power generator can arise through:

- Incorrect operation
- Transportation
- Hot parts
- Recoil of the Engine starter cable

- Environmental Hazards** Environmental hazards from the generator can arise from:
- Incorrect operation
 - Operating materials (fuel, lubricants, Engine oils etc.)
 - Exhaust emissions
 - Sound emissions
 - Risk of fire
- Material damage to the Electrical Generator** Material damage to the electrical generator can arise from:
- Incorrect operation
 - Overloading
 - Over heating
 - Too low / too levels of high Engine oil
 - Failure to observe operating and servicing guidelines
 - Use of improper operating materials
- Material Damage to other Property** Material damage to other property in the vicinity of the power generator can arise from:
- Incorrect operation
 - Excess or undervoltage
- Reduction in the Performance and Functionality** Reduction in the performance or function of the power generator can arise from:
- Incorrect operation
 - Incorrect servicing or repair
 - Unsuitable operating materials
 - An operational location more than 100 meters above sea level
 - An ambient temperature above 25°C
 - Excessive size of the distribution network

2.2 Qualifications and Duties

All activities in relation to the electrical generator may only be carried out by personnel qualified for this purpose.

They must

- know and apply the Prevention of Injury regulations and the safety instructions for the power generator.
- have read the "General Safety Guidelines" section.
- have understood the contents of the "General Safety Guidelines" section.
- be able to practically implement the contents of the "General Safety Guidelines" section.
- understand and be able to practically implement the technical documentation.

2.3 Personal Safety Equipment

You must wear the following personal safety equipment during all activity with the power generator as described in these instructions:

- Hearing protection
- Protective gloves

2.4 Hazard Areas and Work Places

The hazard areas and work places (work areas) for the power generator are defined for the activity undertaken within the individual work phase:

Work Phase	Activity	Hazard Area	Work Area
Transportation	In vehicle	Radius of 1.0 m	none
	By operating personnel		Radius of 1.0 m
Operation	Set up		
	Operating	Radius of 5.0 m	
	Re-fuelling	Radius of 2.0 m	
Maintenance and Servicing	Cleaning	Radius of 1.0 m	
	Shut down		
	Servicing		

Tab. 2.1: Hazard Areas and Work Places of the Power Generator







2.5 Labelling on the Electrical Generator

These labels must be attached to the electrical generator and be easy to read:



Fig. 2.1: Labels on the generator

- | | | | |
|---|---------------------------|---|----------------------------|
| 1 | General warnings | 5 | Hot surface warning |
| 2 | Earth | 6 | Fuel cock warning |
| 3 | Sound power level warning | 7 | Choke (cold start) warning |
| 4 | Fire hazard warning | 8 | Model plate |

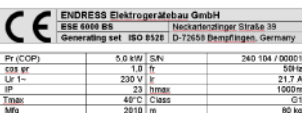
Label	Designation	No.
	General warnings	1
	Earth	2
	Sound power level warning	3
	Fire hazard warning	4
	Hot surface warning	5
	Fuel tap warning	6
	Choke	7
	Model plate See page 40 for explanation	8

Tab. 2.2: Labels on the generator

2.6 General Safety Instructions

The operator must know the functions of, and be able to use, the components of the power generator.

The operator is responsible for the safe operation of the power generator.

The operator is responsible for preventing unauthorized use of the power generator.

The operator must wear the appropriate personal safety equipment.

The labelling on the electrical generator must be complete and maintained in a readable condition.

Constructive changes may not be carried out on the electrical generator.

The rated speed of the motor has been set during manufacture and may not be changed.

The operating safety and correct functioning must be checked before and after each use.

The power generator may only be used outside.

No naked flames, lights or spark-emitting appliances may be used within the hazard area of the power generator.

Smoking within the hazard area of the power generator is strictly forbidden.

During operation, the power generator must be protected against dampness and precipitation (rain, snow).

During operation, the power generator must be protected from dirt and foreign matter.

Transporting The power generator may only be transported when cold.

The power generator may only be transported by vehicle where there is adequate protection against tipping.

The power generator may only be lifted using the carry handles intended for this purpose.

Set up The power generator may only be set up on adequately stable surfaces.

The power generator may only be set up on even surfaces.

The power generator may not be set up on wet surfaces.

Power generation The electrical safety must be checked before each operational use.

The appliance may not be covered.

The air intake may not be blocked or obstructed.

Starting aids may not be used.

When starting, the load may not be connected.

Only certified and approved cables may be used for the wired network.

The power output may not exceed the maximum rated power.

The power generator may not be operated without the sound absorber.

The power generator may not be operated without the air filter or with the air filter cover open.

- Fuelling** The generator's tank may not be refilled during operating.
- The tank may not be refilled when the power generator is hot.
- Use a filling device (funnel) when re-filling.
- Cleaning** The power generator may not be cleaned when in operation.
- The power generator may not be cleaned when hot.
- Maintenance and Servicing** The power generator may not be serviced when in operation.
- The power generator may not be serviced when hot.
- The operator may only carry out servicing and repair work that conforms to these instructions.
- All other servicing and repair work may only be carried out by personnel who are qualified and licensed for this purpose.
- Always remove spark plug connector prior to commencing servicing and repair work.
- The service intervals set out in these instructions must be observed.
- Shut down** The power generator must be shut down when not required for periods longer than 30 days.
- The power generator must be stored in a dry enclosed room.
- A fuel additive should be used to prevent resinous residues.

**Notice on Protection
of the Environment**

The packaging material should be recycled in accordance with the locally applicable regulations for the protection of the environment.

To prevent contamination the operational location must be protected against the leakage of operating materials.

Used or residual operating materials should be recycled in accordance with the locally applicable regulations for the protection of the environment.

Electrical and electronic devices, batteries and rechargeable batteries may not be disposed of in domestic waste.

The user is legally obliged to return electrical and electronic devices, batteries and rechargeable batteries, at the end of their useful life, to the designated public collection facilities or to the point of sale. This is indicated either by the symbol on the product, the instructions for use or the packaging.

Batteries and rechargeable batteries must be removed from devices and disposed of separately.

You are making an important contribution to the protection of our environment by carrying out recycling, material recycling or other forms of recycling of used appliances and devices.

3 Description



This section describes the power generator's components and functions.

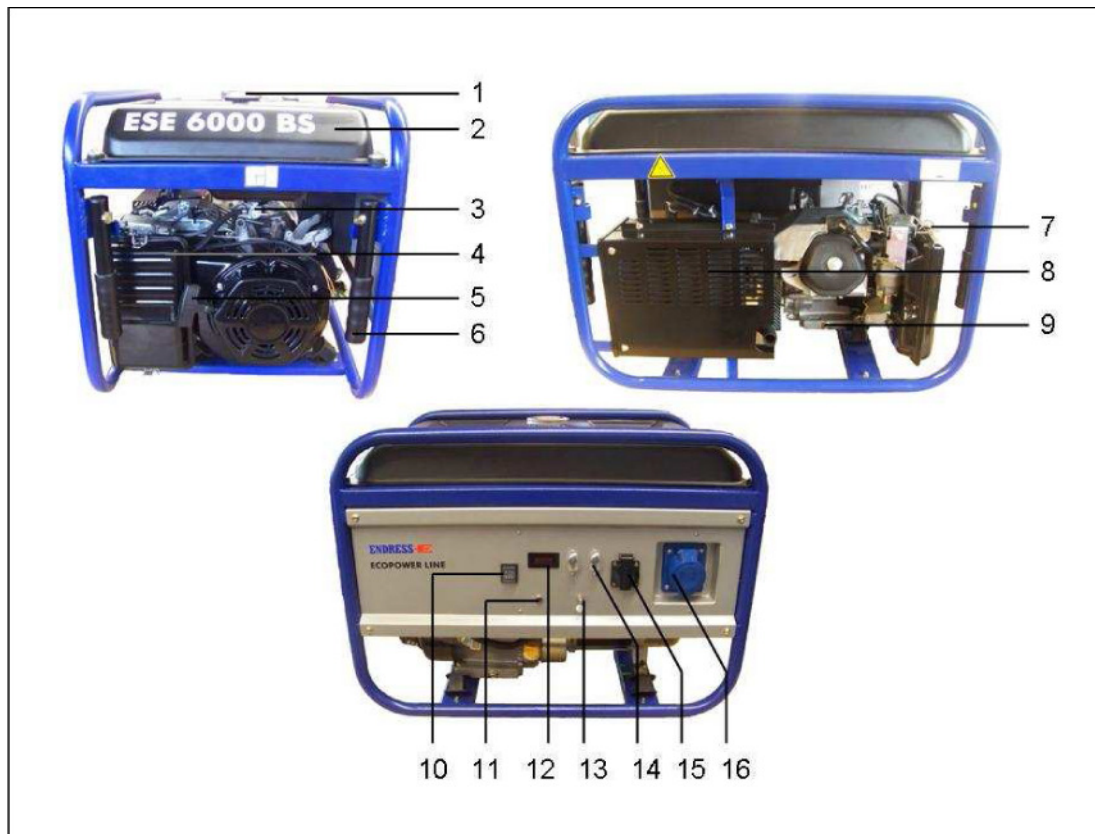

Fig. 3.1: Components of the generator

- | | | | |
|---|------------------------|----|-----------------------------------|
| 1 | Fuel cap | 9 | Oil drain plug |
| 2 | Fuel tank | 10 | Rocker switch for Engine (On/Off) |
| 3 | Fuel valve | 11 | Low oil light |
| 4 | Air filter | 12 | Volt./Freq./Hrs meters |
| 5 | Rope starter for motor | 13 | Ground connection screw |
| 6 | Carrying handle | 14 | Circuit breaker |
| 7 | Choke | 15 | Electric safety socket |
| 8 | Muffler | 16 | CEE socket |

3.1 Function and Mode of Operation

The synchronous generator is rigidly coupled to the drive Engine. The aggregate is mounted on a stable base plate and is housed elastically in a low vibration state.

Power consumption is via a splash-proof shock-proof 230 V / 50 Hz socket.

The generator's voltage regulation is provided within rated speed limits by an automatic voltage regulator (AVR)

AVR = Automatic Voltage Regulator

The AVR evens out voltage peaks making it especially suitable for electronic loads, e.g. electronically regulated power tools such as drills as well as domestic appliances such as cookers, heaters, television etc.

The power generator is designed for mobile operation with one or several loads. Stationary operation required.
The power generator's potential equalization (protective separation) is implemented by means of a separate cable that must be connected to a device that is suitable for earthing. (not supplied)

4 Putting the Power Generator into Operation



This section describes the operation of the power generator.

4.1 Dismantling the transport safety device

1. Undo securing screws at both ends of the red transport safety devices (see Fig. -2- (1)).
 2. Now remove the safety devices.
- ✓ Dismantling the safety devices has now been completed.

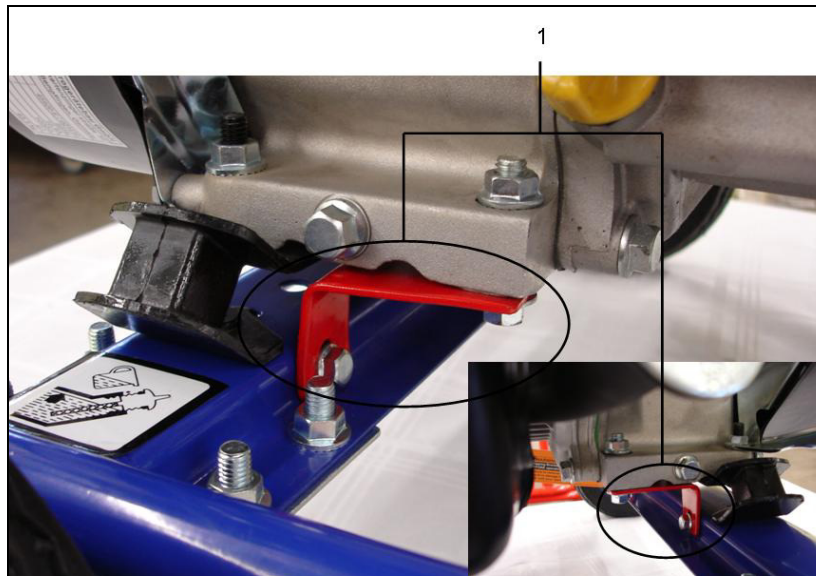

Figure 2: Transport safety device

Note Keep the two transport safety devices and the screws safely in case they will be needed again.

4.2 Transporting the Power Generator

Proceed as follows when transporting the power generator.

Requirements These requirements must be fulfilled:

- Power generator is turned off
- Power generator has cooled down
- Air vent is in the OFF position



CAUTION!

A slipping or falling generator can crush hands or feet.

- Beware of weight — 30 to 92 kg (depending on model).
- The device must be carried by 2 people (ESE 1100 BS / ESE 2000 BS) or 4 people (ESE 4000 BS / ESE 6000 BS).
- Walk slowly.
- Keep feet out from under the device.

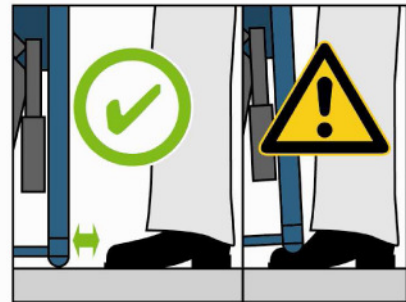

- Carrying the appliance**
3. Take firm hold of carry grips.
 4. Lift appliance.
 5. Carry appliance to operating point.
 6. Lower appliance.
 7. Release carry grip.
- ✓ The appliance has been carried to the operating point.

4.3 Setting-up the Power Generator

Proceed as follows in order to set-up the power generator.

Requirements These requirements must be fulfilled:

- level and stable surface outdoors
- operating area is free of flammable materials
- operating area is free of explosive materials
- The device must be set up in the open (it must not be covered).



CAUTION!

Leaking engine oil and petrol can contaminate soil and groundwater.

- Prevent engine oil and petrol leaks.

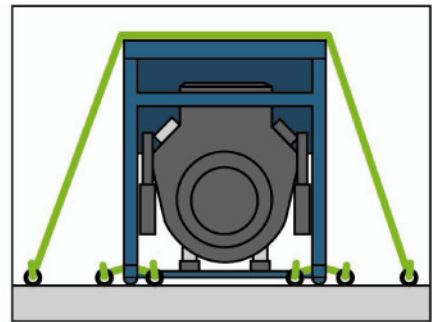
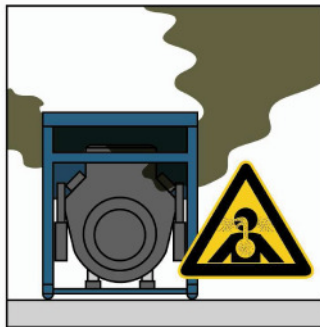

Setting up the generator The generator is set up as follows:

1. Prepare the work area.
 2. Transport the generator to the work area.
 3. If necessary, secure the device against tilting or slipping.
- ✓ The device has now been set up.

4.4 Fuelling the Power Generator

Proceeds as follows to fuel the power generator.

Requirements These requirements must be fulfilled:

- appliance is switched off
- appliance is cool
- adequate air supply and ventilation



WARNING!

Leaking fuel can combust or explode.

- Avoid fuel leakages.
- Appliance is switched off.
- Appliance is cooled.
- Avoid naked flames and sparks.



CAUTION!

Leaking engine oil can contaminate soil and groundwater.

- Do not fill the tank completely.
- Use pour spout.



CAUTION!

Incorrect fuel destroys the engine.

- Only refuel with lead-free regular grade petrol ROZ 91.

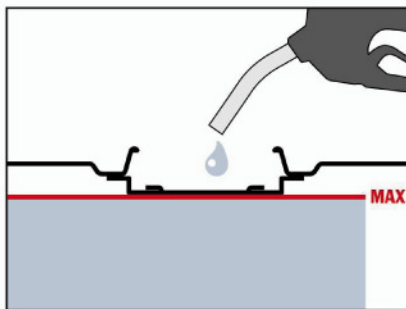

Fuelling the appliance**The power generator is fuelled as follows:**

1. Push the fuel valve to the OFF position
 2. Unscrew the tank cap.
 3. Insert filling device (funnel) into the tank.
 4. Fill with fuel.
 5. Remove the filling device.
 6. Replace the tank cap
- ✓ The appliance is fuelled.

4.5 Filling the Power Generator with Motor Oil

**WARNING!**

The power generator is, as a rule, delivered without oil.

- it is not possible to start the appliance if the oil level is too low, because the motor is fitted with an oil monitor.

Proceed as follows to fill the appliance with motor oil.

Requirements

These requirements must be fulfilled:

- appliance is switched off
- appliance is cool

**WARNING!**

Leaking motor oil contaminates the soil and ground water.

- Do not fill crankcase to maximum (check the volume with oil dipstick).
- Use filling device (funnel).



WARNING!

Incorrect motor oil will damage motor irreparably. Please check the ambient temperature and fill with the following listed oil type:

- < 0° => SAE 10 or 10W30; 10W40
- 0°-25° => SAE 20 or 10W30; 10W40
- 25°-35° => SAE 30 or 10W30; 10W40
- 35° > ... => SAE 40 or 10W30; 10W40
- Do not add any standard additives to the oil.

Filling the appliance with motor oil

Proceed as follows to fill the power generator with motor oil:

1. Unscrew oil dipstick.
 2. Insert filling device (funnel) into the opening.(not supplied)
 3. Fill motor oil up to the edge of the oil-filler neck.
(Oil quantity, see page 40 "Technical data").
 4. Remove filling device.
 5. Replace oil dipstick.
 6. If oil level is too low, repeat filling procedure.
 7. Tighten oil dipstick
- ✓ The appliance is filled with motor oil.

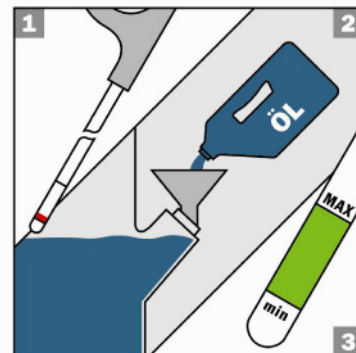
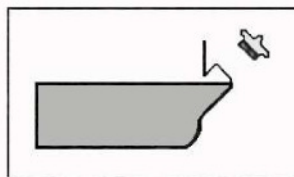

4.6 Starting the Power Generator

Proceed as follows in order to start the power generator.

Requirements These requirements must be fulfilled:

- electrical safety is checked
- fuel tank is filled
- adequate oil level
- adequate air supply and ventilation
- load is switched off or disconnected



WARNING!

Operating materials can combust or explode.

- Avoid leakage of motor oil and fuel.
- Do not use ignition aids.
- Avoid naked flames and sparks.

Turn on engine fuel supply

Engine fuel supply is by means of the power generator's own fuel tank.

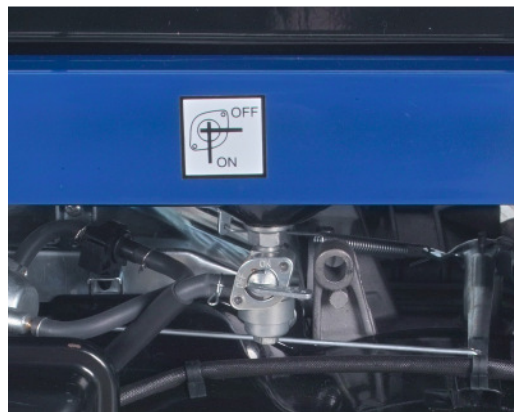

Fig. 4.1: Open/close fuel valve

Switch position	Function
OFF	Closed
ON	Open

Tab. 4.1: Air vent switch position.

You turn on the engine fuel supply as follows:

1. Air vent switch to position ON.
- ✓ The engine fuel supply is turned on.



WARNING!

Exhaust fumes affect the respiratory system with potentially fatal consequences.

- Ensure there is adequate ventilation.
- Only use appliance outdoors.



WARNING!

Hot components can ignite flammable and explosive materials.

- Avoid flammable materials at operating area.
- Avoid explosive materials at operating area.



WARNING!

Heat or wetness damages the appliance irreparably.

- Avoid overheating (adequate ventilation).
- Avoid wetness.

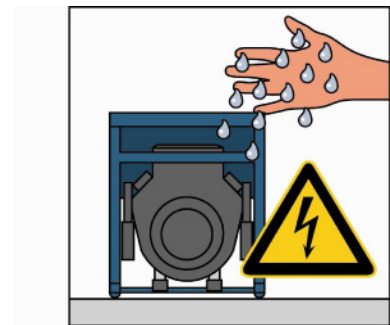

Starting the motor You start the motor as follows:



Fig. 4.2: Starting the engine

- 1** Choke (cold start)
- 2** Rocker switch for motor (Position - ON)
- 3** Rope starter for motor

1. Push choke lever to **START** position “see air filter label” (for cold engine only).
 2. Push Rocker switch of motor to **ON** position.
 3. Pull cable grip slowly out to point of action, then pull with a swift but fluid movement.
- ✓ The motor begins to start.

In order to ease the pulling action, brace yourself with one hand on the appliance grip,

4. Push the choke level to the **RUN** position.
- ✓ The motor is started.

- ELECTROSTART**
1. Move choke into the start position “see air filter label” (only if motor is cold).
 2. Turn the key-switch to the right and hold it in the START position until the motor starts and then release it.
 - ✓ The motor starts up.
 4. Move the choke into the start position.
 - ✓ The motor has started.

NOTE Activate the starter briefly (max. 5 – 10 sec). Never start the motor or leave it to run with a battery clamped on it.

NOTE The electrical consumer can be connected up or switched in after a warming-up phase of approx. one minute has been completed.

Connecting load

Proceed as follows to connect the load to the power generator.

Requirements The following requirements must be fulfilled:

- the power generator is started
- warm up period is complete
- load is turned off



WARNING!

Electric shocks cause injuries with potentially fatal consequences.

- The power generator must not be connected to other electric supply systems (e.g. public supply systems) or electrical generation systems (e.g. other power generators).

Connecting load You can use a safety plug (230V AC) or (400V 3-phase AC for ESE 6000 DBS (ES) only) to interconnect the consumers.

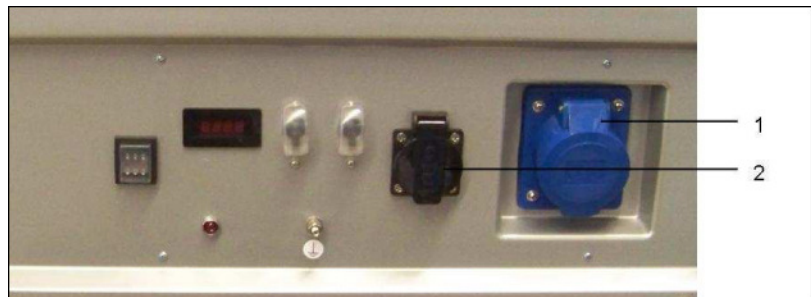

Fig. 4.3: Connecting consumers

1 CEE socket 2 Electric safety socket 230 V 1~

Connecting load Proceed as follows to connect a load to the shockproof socket:

1. Lift cover.
 2. Insert shock-proof plug.
- ✓ The load is connected to the power generator.

Switch on load You switch on the load as follows:

1. Switch on load.
- ✓ The load is switched on.

Switch off load You switch off the load as follows:

1. Switch off load.
- ✓ The load is switched off.

Disconnect load You disconnect the load from the power generator as follows:

1. Remove plug.
- ✓ The load is disconnected from the power generator.

4.7 Switching off the Power Generator

Proceed as follows to switch off the power generator.



WARNING!

Hot components can ignite flammable and explosive materials.

- Avoid flammable materials at the operating area.
- Avoid explosive materials at the operating area.
- Allow appliance to cool.

You switch off the appliance as follows:

1. Switch off or disconnect load.
2. Allow motor to continue running for approx. a further two minutes.



Fig. 4.4: Turn off the motor

1 Rocker switch for motor (Position - ON) **2** Choke (cold start)

3. Push the Rocker switch of motor to the **OFF** position.
✓ The motor is off.
4. Push fuel valve switch to the **OFF** position.
5. Allow appliance to cool.
✓ The appliance is switched off.

4.8 Shutting down Power Generator (longer term shut down)

Infrequent use Starting problems may be experienced if the electrical generator is only used infrequently.

To avoid these problems the generator should be run for approx. 30 minutes per week.

Storage If you do not require the power generator for a longer period of time, shut the generator down and put it into storage.

Proceed as follows to shut down the generator.

Requirements These requirements must be fulfilled:

- load is switched off or disconnected
- appliance is switched off
- appliance is still a little warm



WARNING!

Leaking motor oil and fuel contaminates the soil and ground water.

Draining motor oil Drain the motor oil from generator as follows:

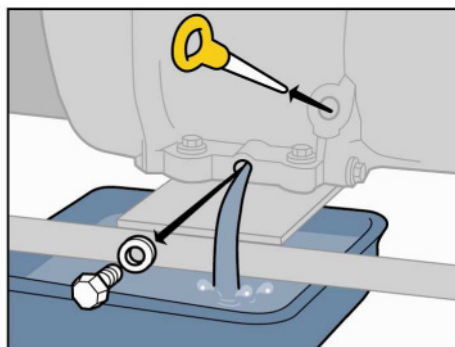

Fig. 4. 5: Remove the oil drain plu

1. Hold catchment tank under the oil drain screw

Note The catchment tank capacity varies depending on the model (0.5 or 1.5 litre). Precise details can be found on page 40 in the “motor oil fill” table.

2. Use wrench to loosen and remove oil drain screw
3. Drain engine oil

Protection of the environment Used or residual operating materials should be disposed of according to the locally applicable recycling regulations for the protection of the environment.

4. Replace oil drain screw and tighten with wrench
- ✓ The motor oil is drained.

Drain fuel tank Proceed as follows to empty generator’s fuel tank:



Fig. 4.6: Shut the fuel valve

1. Place the catchment tank beside the generator.

NOTE The catchment tank capacity varies depending on the model. Precise details can be found on page 40 in the “Tank contents” table.

Push fuel valve switch to the **OFF** position

2. Carefully disconnect fuel pipe from carburettor and allow to drain into catchment tank.
3. Push fuel valve switch to the **ON** position

✓ Fuel is drained.

Protection of the environment Used or residual operating materials should be disposed of according to the locally applicable recycling regulations for the protection of the environment

Push fuel valve switch to the **OFF** position

4. Carefully reconnect the fuel pipe to the carburettor
- ✓ Fuel is drained.

Conservation of engine compartment Requirements

You conserve the engine compartment as follows:

These requirements must be fulfilled:

- appliance is turned off
- no more fuel in the tank
- Fuel valve in OFF position

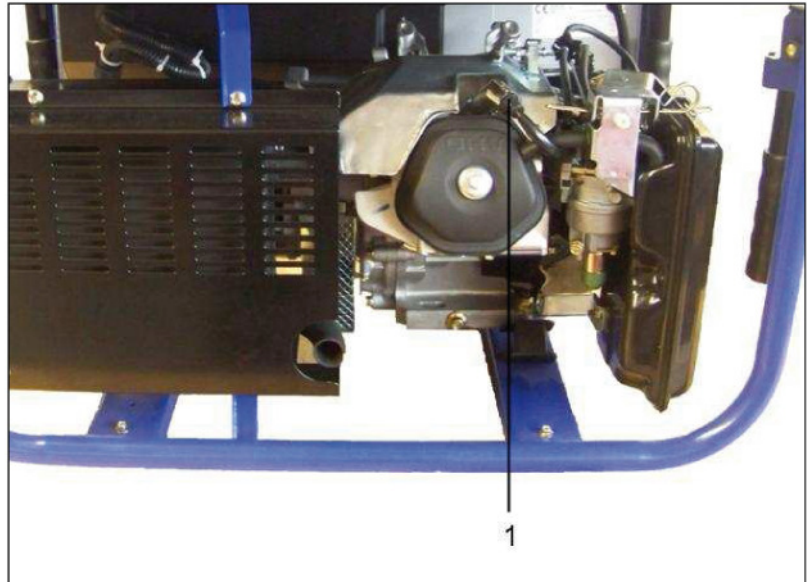

Fig. 4.7: Pull off the spark plug connector

1. Remove spark-plug connector
 2. Remove spark-plug with a spark-plug wrench.
 3. Apply approx. 1 ml oil to the spark-plug aperture.
 4. Screw spark-plug back in and tighten.
 5. Pull the starter cable several times slowly so that the oil is distributed around the engine compartment.
 6. Re-insert the spark-plug connector
- ✓ The engine compartment is conserved.

Cleaning the air filter **The air filter of the generator is cleaned as follows:**

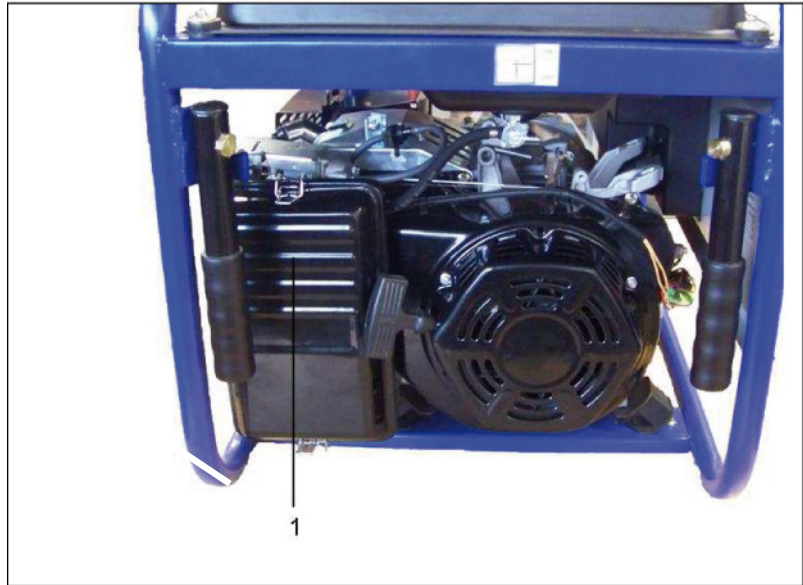

Fig. 4.8: Remove the air filter

1. Remove air filter cover from air filter housing
 2. Clean the air filter insert in a suitable container in warm water with dish detergent or with nonflammable cleaning solvent.
 3. Pour some motor oil onto the filter and press out excess oil.
 4. Replace air filter
 5. Replace air filter cover onto air filter housing
- ✓ Air filter is cleaned and mounted.

Protection of the environment

Used or residual operating materials should be disposed of according to the locally applicable recycling regulations for the protection of the environment.

5 Servicing the Power Generator



This section describes how to service the generator.

Servicing and repair work not described in this section must be carried out by the manufacturer's personnel.

5.1 Service Plan

The following servicing work must be carried out in accordance with the corresponding periods.

Servicing work	Intervals in operating hours [h]					
	after 8 h	every 8 h / daily	every 25 h / yearly	every 50 h / yearly	every 100 h / yearly	yearly
Check electrical safety	before each operation					
Check oil level	before each operation					
Change oil	X			(X)¹⁾		
Clean air filter			(X)²⁾			
Clean area around exhaust silencer, linkage and springs		X				
Change spark-plugs						X
Change fuel filter						(X)³⁾
Check fitting of screws, nuts and bolts					X	
Check idle speed						(X)⁴⁾
Check valve clearance						(X)⁴⁾
Check condition and leak tightness of fuel lines and connections.					X	
Clean combustion chamber	every 500h⁴⁾					

Tab. 5.1: Servicing plan for power generator

1) Every 25 h for operation under heavy loads or high ambient temperatures.

2) Clean often in very dusty conditions or where there are high accumulations of foreign matter or during longer periods of use in long dry grass.

3) Where applicable

4) To be done by an Endress-Service-Station.

5.2 Servicing work

Servicing work should only be carried out by personnel qualified for this purpose.

All the works listed in the service plan are to be carried out in accordance with the operating and service instructions for the motor.

We recommend that these works be carried out by an authorised **ENDRESS Service station**.

5.3 Checking Electrical Safety

The electrical safety may only be checked by personnel authorised for this task.

The electrical safety must be checked in accordance with the applicable German VDE regulations, EN and DIN norms and the special Prevention of Accident Regulations BGV A3 in the relevant applicable version.

6 Trouble Shooting



This section describes how qualified personnel can repair problems that arise during operating.

Each problem is described with the possible cause and the applicable method by which it can be remedied.

If a problem listed in the following table cannot be repaired, the responsible personnel must switch off the power generator immediately and inform the responsible authorised service personnel.

***It is recommended that a service station be consulted for checks or repairs here**

Fault	Possible cause	Remedy
No power from the socket	Engine speed too low	*Adjust engine speed
	Open circuit or short-circuited wiring	Check load
	Defective Condenser/AVR	*Replace Condenser/AVR
	Rotor or stator winding open/short-circuited	*Test winding resistance, if required replace the winding
	Circuit breaker in OFF position	Push circuit breaker to ON position
Low output voltage with no load	Engine speed too low	*Adjust engine speed
	Rectifier	*Test rectifier, replace if required
	Defective Condenser/AVR	*Replace Condenser/AVR
	Rotor or stator winding open/short-circuited	* Test winding resistance, if required replace the winding
	Generator not magnetised	*Re-magnetise generator
High output voltage with no load	Engine speed too high	* Adjust engine speed
	Engine speed too low	*Adjust engine speed
Low output voltage with load	Rectifier	*Test rectifier, replace if required
	Machine speed too low at full load	*Adjust engine speed
	Too much load applied	Reduce applied load
Irregular output voltage	Irregular load applied	Disconnect complete load, then reconnect individually in order to determine which is causing the irregular function.

Fault	Possible cause	Remedy
Noisy operation	Loose generator or machine screw	Tighten all mounting parts
	Short-circuit in generator field/load	*Test winding resistance, replace field winding, check load appliances if required. Replace defective load appliances.
	Defective bearing	*Replace bearing.
Engine will not start	No fuel	Check fuel
	Fuel valve in OFF position	Push fuel valve to open position ON
	Rocker switch in OFF position	Push rocker switch to ON position
	Spark plug connector is dirty or loose	Clean spark-plug connector. Adjust aperture, replace if necessary
	Spark plug is dirty	Clean spark plug, replace if necessary
	Pilot light illuminated when starting → oil level too low	Check oil level, fill with oil if required

Tab. 6.1: Operational problems of the power generator

*** It is recommended that a service station be consulted for checks or repairs here**

7 Technical Data



This section contains technical information on the operation of the power generator.

Technical data

Designation			
Model	ESE 3000 BS	ESE 6000 BS	ESE 6000 DBS
Generator (AVR)	synchronous	synchronous	Synchronous
Frequency / protection class	50 Hz / IP 23	50 Hz / IP 23	50 Hz / IP 23
Nominal voltage	230 V 1~	230 V 1~	400 V 3~ / 230V 1~
Max. output power (LTP) VA	2800	5500	6900/3600
Continuous rating (COP) Watts	2500	5000	6250/3300
Power factor rating $\cos/(\phi)$	1	1	0,8/1
Phasing	Single phase	Single phase	3 phase
Engine type	1-cylinder 4-cycle air cooled OHV	1-cylinder 4-cycle air cooled OHV	1-cylinder 4-cycle air cooled OHV
Capacity in cm ³	193	357	357
Maximum power in kW	6,5	12	12
Tank capacity (litres)	20	30	30
Noise pressure level in the workplace L_{pA} *	87dB(A)	89dB(A)	89dB(A)
Noise pressure level in 7m distance L_{pA} **	71dB(A)	73dB(A)	73dB(A)
Sound power level ** L_{WA}	95dB(A)	97dB(A)	97dB(A)
Length in mm	640	786	786
Width in mm	475	570	570
Height in mm	526	600	600
Weight kg	52	84	90
Motor oil quantity	0,6 Liter	1,1 Liter	1,1Liter

Tab. 7.1: Power generator specifications

* Measured at a distance of 1m and a height of 1.6m in accordance with ISO 3744 (Part 10)

** Measured in accordance with ISO 3744 (Part 10)

Ambient conditions

Description	Value	Unit
set up height about sea-level	< 100	[m]
temperature	< 25	[°C]
relative humidity	< 30	[%]

Tab. 7.2: Ambient conditions for the power generator

Reduced output

Reduction in output	each additional	Unit
1 %	100	[m]
4 %	10	[°C]

Tab. 7.3: Reduced output of the power generator dependent on the ambient conditions

Distribution network

Circuit	max. circuit length	Unit
1.5 mm ² HO 7 RN-F or equivalent	60	[m]
2.5 mm ² HO 7 RN-F or equivalent	100	[m]

Tab. 7.4: Maximum circuit length of the distribution network based on diameter of wiring

Explanation of type plate

		ENDRESS Elektrogerätebau GmbH	
		ESE 6000 BS Generating set	ISO 8528
		Neckartenzlinger Straße 39 D-72658 Bempflingen, Germany	
Pr (COP)	5 kW	S/N	240204/ 00001
cos r	1.0	fr	50 Hz
Ur 1~	230 V	Ir	21.7A
IP	23	hmax	1000m
Tmax	40°C	Class	G1
Mfg	2010	m	80 kg

Rated power in kW	Serial number
Rated power factor	Rated frequency in Hertz
Rated voltage in volts	Rated current in amps
International protection class	Maximum set up height in metres
Maximum ambient temperature	Type class
Year of manufacture	Weight in kilograms

8 Terms of Warranty

Please consult the dealership where you purchased our product in the event of a claim under the warranty or for replacement parts.

Please note that the following documentation must, in every case, accompany the defective appliance:

- Purchase documentation (till receipt or invoice)
- Description of the defect that has arisen

Service – Hotline

Telephone: +49(0)7123-9737-44

Email: Service@endress-generators.de

ENDRESS Elektrogerätebau GmbH • Neckartenzlinger Straße 39 • D 72658 Bempflingen
Telephone: +49-(0)-7123-9737-0 • Telefax: +49-(0)-7123-9737-10 • Email: Info@endress-generators.de • www.endress-generators.de

EG-Konformitätserklärung Declaration of Conformity		Declaration de conformité européenne Declaración de conformidad
Name und Anschrift der Person, die die technischen Unterlagen aufbewahrt Name and address of the person who keeps the technical documentation Nom et adresse de la personne qui garde la documentation technique Nombre y dirección del encargado de la documentación técnica		Hans Braun ENDRESS Elektrogerätebau GmbH Neckartenzlinger Straße 39 D - 72658 Bempflingen

KRAFTSTROMGENERATOR

Power Generator, Générateur d'alimentation, Grupo electrogeno

Handelsbezeichnung Trade name Dénomination commerciale Nombre comercial ESE 3000 BS	Artikel-Nr: Order-nr. Numéro d'article numero del artículo 240209
ESE 6000 BS	240210
ESE 6000 DBS	240211

erklären in alleiniger Verantwortung, dass obiges Produkt auf das sich diese Erklärung bezieht folgenden einschlägigen Richtlinien und Normen entspricht

declare under our sole responsibility that the product to which this declaration relates is in conformity with the following relevant regulations
 déclarons sous notre seule responsabilité, que le produit auquel se réfère cette déclaration est conforme aux normes suivantes
 declara bajo responsabilidad propia, que el producto al que se refiere esta declaración, es conforme a las siguientes normas o directrices

Angewendete Richtlinien

2006 / 42 / EG
2004 / 108 / EG
2002 / 88 / EG
2000 / 14 / EG
2005 / 88 / EG

Angewendete Normen

EN 55012
EN 55014
EN 60335-1
EN 60204-1
EN 12601

einschließlich nachfolgender Änderungen und Ergänzungen
 and subsequent modification and integrations
 et aux modifications successives et intégrations
 y sucesivas modificaciones y integraciones

Gemessener Schalleistungspegel LWA Measured sound power level LWA Niveau de puissance sonore mesuré LWA Nivel de potencia sonora medida LWA		Garantierter Schalleistungspegel LWA Guaranteed sound power level LWA Niveau de puissance sonore garanti en LWA Nivel de potencia sonora garantizada LWA	
96 dB(A)	Art.-Nr: 240209	96 dB(A)	Art.-Nr: 240209
97 dB(A)	Art.-Nr: 240210	97dB(A)	Art.-Nr: 240210
97 dB(A)	Art.-Nr: 240211	97dB(A)	Art.-Nr: 240211

Messverfahren entsprechend ISO 3744 (Teil10)
 measuring procedure according to ISO 3744 (part10)
 procédé de repérage conformément à ISO 3744 (part10)
 el procedimiento de medición conforme a ISO 3744 (part10)

Bewertungsverfahren zur Feststellung der Übereinstimmung nach 2000/14/EC Anlage VIII. (Benachrichtigte Stelle)

conformity assesment procedure according to 2000/14/EC procedure VIII. (notified body)

procède d'évaluation de conformité 2000/14/EC procédure VIII. (organisme avisé:)

Bewertungsverfahren zur Feststellung der Übereinstimmung nach 2000/14/EC Beilage VIII. (Benachrichtigte Stelle:)

European Commission
 Directorate General Environment
 Unit C.1 "Air, Noise & Transport"
 BL-9 06/200 - B-1049 Brussels
 Belgium

verantwortlich
 authorized by
 le responsable
 el responsable



Bempflingen, Dezember 2012	 Christian Weissinger Geschäftsführer
----------------------------	---

Accessories: Wheelset can be ordered optional



Make everything easier by using the correct gearing set for your power generator:

Available as accessories for the following models:

ESE 2000 BS Order No. 161 029

Notes
